

Varenummer: 40550400312445
 Beskrivelse: Tandhjulsgeær S401F-3,1-P112B5

Mål

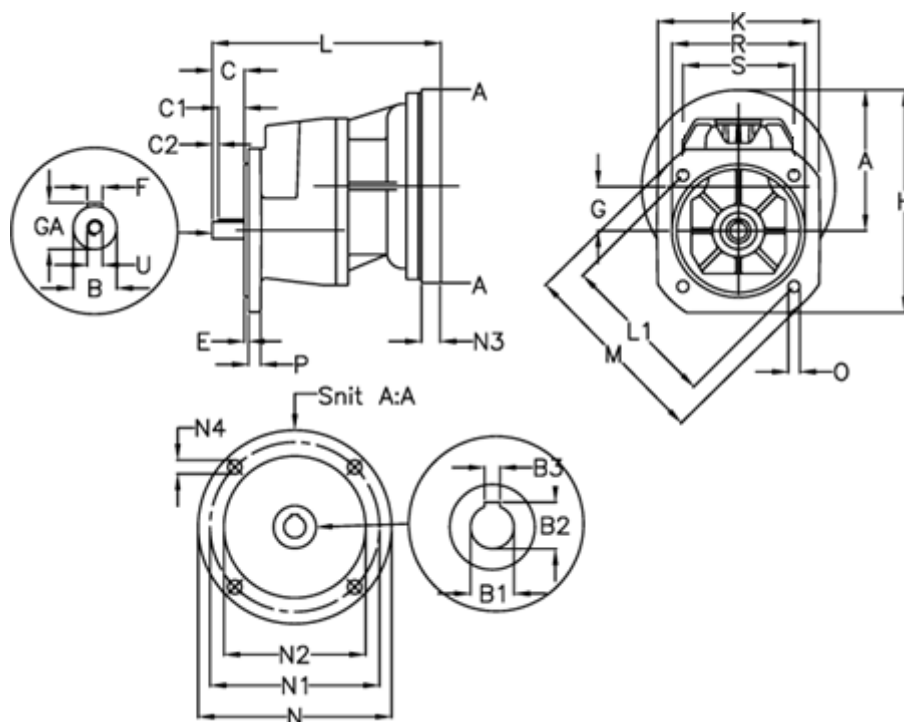

A = 154.7	E = 4.0	M = 250.0	R = 180
B = 28	F = 8x7x50	N = 250	S = 155
B1 = 28	G = 61.7	N1 = 215	U = M8
B2 = 31.3	GA = 31.0	N2 = 180	
B3 = 8	H = 259.7	N3 = -	
C = 60	K = 210	N4 = M12x16	
C1 = 50	L = 304	O = 14.0	
C2 = 5	L1 = 215.0	P = 12	